

TECHNICAL SHEET

S10-52Y

Standard Reciprocating SERIES

LEGAL DISCLAIMER:

While Frascold has made every effort at the time of publication to ensure the accuracy of the information provided herein, product specifications and performances could be subject to change without notice. You can find the most updated information in our Product Selection Software FSS3 at the link:
https://www.frascold.it/en/download/software/fss_3_frascold_selection_software.



Technical data - S10-52Y

Nominal motor power	HP	10
Nominal motor power	kW	7,5
Displacement @ (1450 rpm - 50 Hz)	m ³ /h	51,5
Displacement @ (1740 rpm - 60 Hz)	m ³ /h	61,8
Power supply	V/ph/Hz/Connection	400/3/50/PWS
MRA	A	24,5
LRA	A	59,1
LRA DOL	A	102,3
Maximum frequency	Hz	87
Minimum frequency	Hz	25
Net weight	kg	120
Oil charge	l	2,9
Maximum operating pressure HP	bar	30
Maximum static pressure LP	bar	20,5
Capacity step	%	100-75-50

Standard accessories - S10-52Y

Suction and discharge valves with soldering connection

Packing ensuring proper handling and protection

IP56 terminal box

Oil level sight glass(es)

Electronic protection module INT69

T00ECA01A

Rubber vibration dampers (4 pcs)

Nitrogen protective charge

Optional accessories - S10-52Y

Special voltage for electrical motor

Crankcase heater

CC capacity control head

RSH capacity control head

US unloaded start head

Head Cooling Fan

FLI liquid injection kit

Oil Equalizing Fitting with valve

USB adapter for Diagnose

T00EC57

Bluetooth Module for Diagnose

T00EC69

Modbus connection cable

T00EC65

DP-Modbus gateway

T00EC59

Special painting

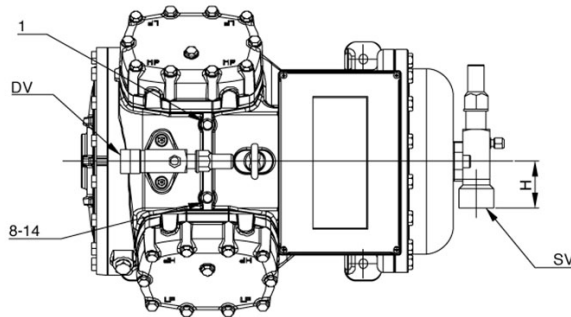
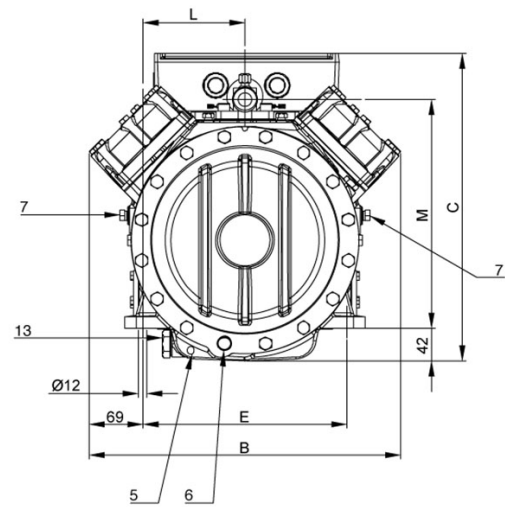
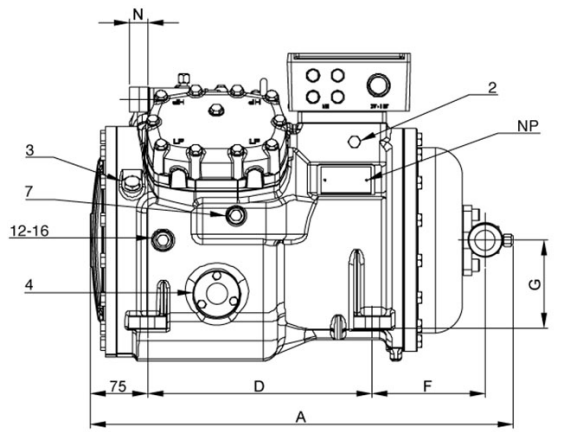

Supporto antivibrante	M10	29
Vibration absorber	50	50
Vibrationsabsorber	M10	29

Position and connections:

SV: Suction Valve	mm	35
SV: Suction Valve	inch	1 3/8"
DV: Discharge valve	mm	28,6
DV: Discharge valve	inch	1 1/8"
A: Length	mm	550
B: Width	mm	405
C: Height	mm	405
D: Base mounting	mm	292
E: Base mounting	mm	266
F: Suction Valve	mm	147
G: Suction Valve	mm	115
H: Suction Valve	mm	58
L: Discharge valve	mm	133
M: Discharge valve	mm	298
N: Discharge valve	mm	23
1: High pressure connection		1/8" NPT
2: Low pressure connection		1/8" NPT
3: Oil charge plug		1/4" GAS
4: Oil level sight glass		-
5: Crankcase heater seat		-
6: Oil drain plug		M10 x 30
7: Liquid injection plug		1/4" NPT
8: Liquid injection sensor plug		1/8" NPT
12: Oil return plug		1/4" NPT
13: Magnetic plug		1/2" GAS
14: Max discharge temperature sensor connection		1/8" NPT
16: Crankcase pressure plug		1/4" NPT
NP: Nameplate		-